

LABOSYSTEM

SISTEMI MODULARI PER LABORATORIO



CATALOGO CODICI

ASTROLAB

TORRE TECNOLOGICA LATERALE

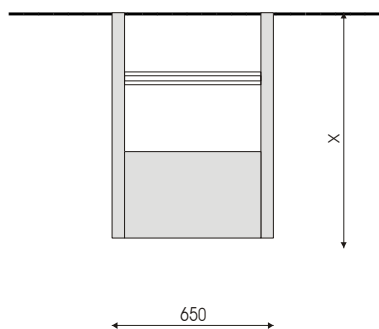

A12065 Supporto a soffitto parete
 Dimensioni (mm.) L 650 x P 150 x H x = variabile

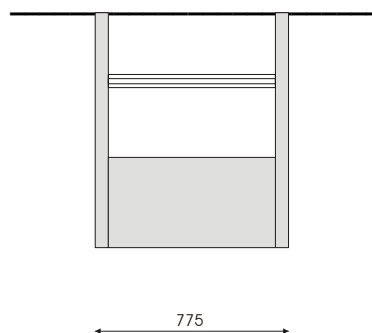

A13075 Supporto a soffitto centrale
 Dimensioni (mm.) L 775 x P 150 x H x = variabile

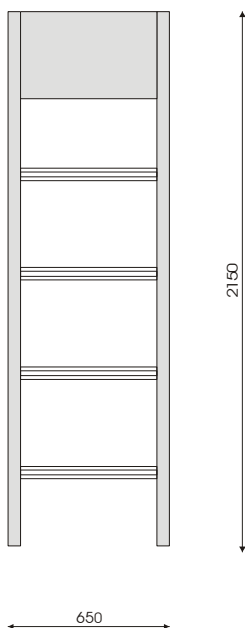

A12165 Torre aperta a parete
 Dimensioni (mm.) L 650 x P 150 x H 2150

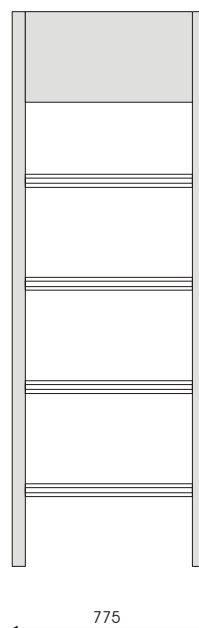

A13175 Torre aperta centrale
 Dimensioni (mm.) L 775 x P 150 x H 2150

TORRE TECNOLOGICA LATERALE

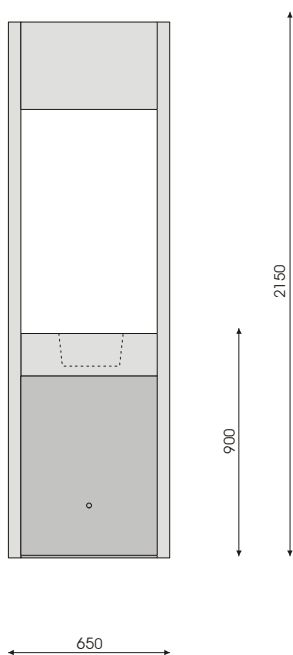

A14065 Torre aperta a parete senza alzata
Dimensioni (mm.) L 650 x P 150 x H 2150

A14065-V Torre aperta a parete senza alzata
con vaschetta in PP
Dimensioni (mm.) L 650 x P 150 x H 2150

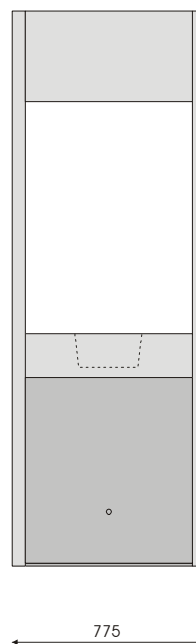

A15075 Torre aperta centrale senza alzata
Dimensioni (mm.) L 775 x P 150 x H 2150

A15075-V Torre aperta centrale senza alzata
con vaschetta in PP
Dimensioni (mm.) L 775 x P 150 x H 2150

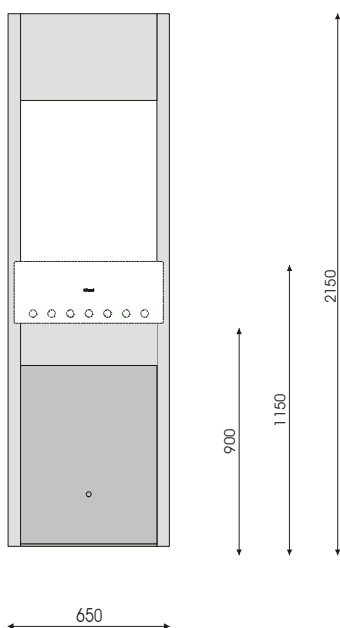

A16065 Torre aperta 1 livello a parete
Dimensioni (mm.) L 650 x P 150 x H 2150

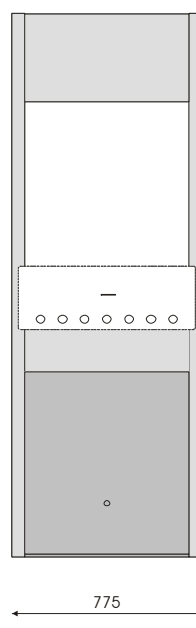

A17075 Torre aperta 1 livello centrale
Dimensioni (mm.) L 775 x P 150 x H 2150

TORRE TECNOLOGICA LATERALE

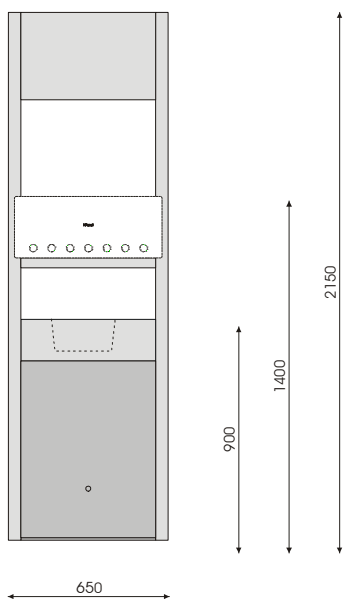

A10065 Torre aperta con vano passante a parete
 Dimensioni (mm.) L 650 x P 150 x H 2150

A10065-V Torre aperta con vano passante a parete con vaschetta in PP
 Dimensioni (mm.) L 650 x P 150 x H 2150

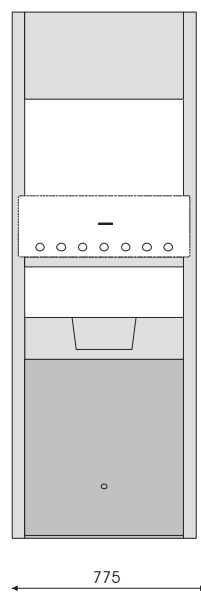

A11075 Torre aperta con vano passante centrale
 Dimensioni (mm.) L 775 x P 150 x H 2150

A11075-V Torre aperta con vano passante centrale con vaschetta in PP
 Dimensioni (mm.) L 775 x P 150 x H 2150

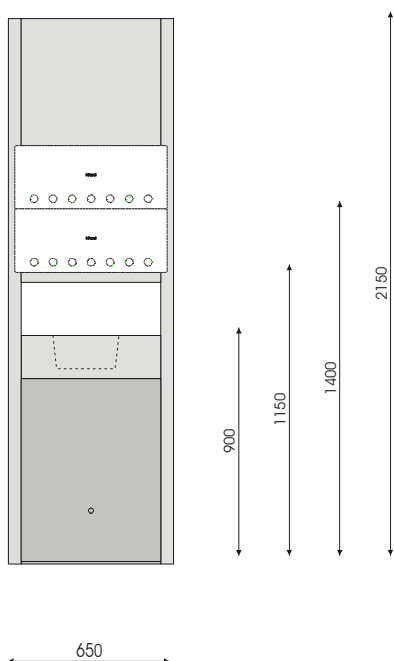

A10165 Torre chiusa con vano passante a parete
 Dimensioni (mm.) L 650 x P 150 x H 2150

A10165-V Torre chiusa con vano passante a parete con vaschetta in PP
 Dimensioni (mm.) L 650 x P 150 x H 2150

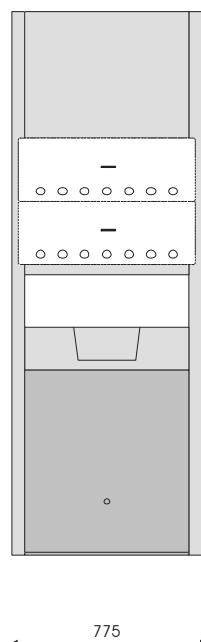

A11175 Torre chiusa con vano passante centrale
 Dimensioni (mm.) L 775 x P 150 x H 2150

A11175-V Torre chiusa con vano passante centrale con vaschetta in PP
 Dimensioni (mm.) L 775 x P 150 x H 2150

TORRE TECNOLOGICA LATERALE

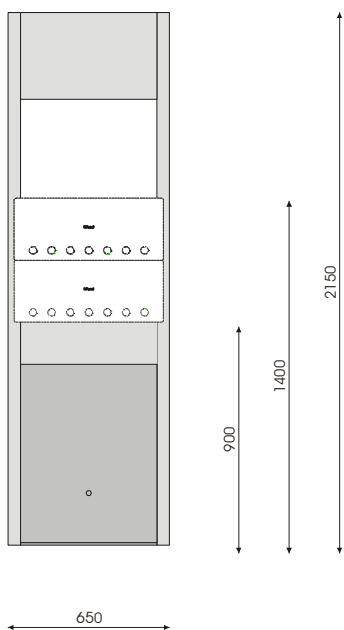

A18065 Torre aperta 2 livelli a parete
Dimensioni (mm.) L 650 x P 150 x H 2150

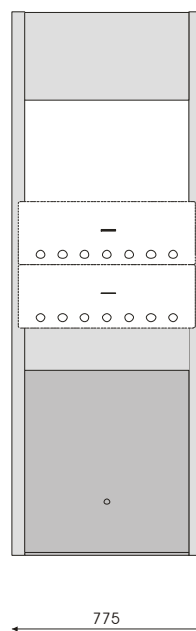

A19075 Torre aperta 2 livelli centrale
Dimensioni (mm.) L 775 x P 150 x H 2150

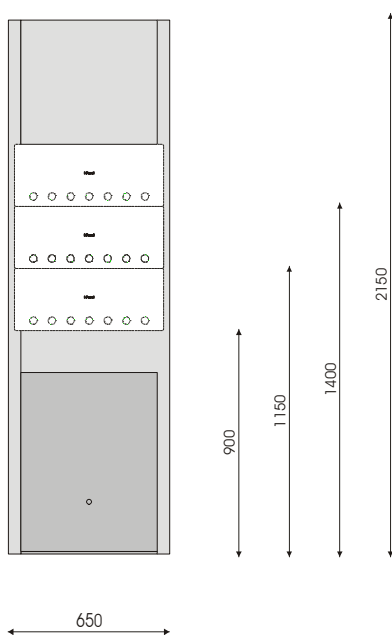

A18165 Torre chiusa a parete
Dimensioni (mm.) L 650 x P 150 x H 2150

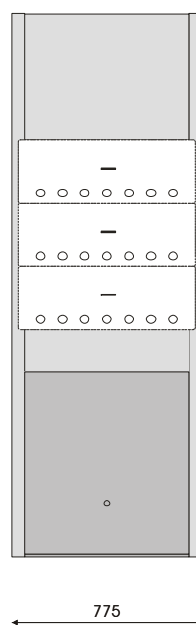

A19175 Torre chiusa centrale
Dimensioni (mm.) L 775 x P 150 x H 2150

SATELLITE PORTA UTENZE

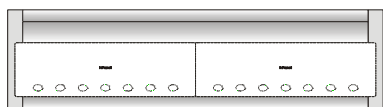

A00120P Satellite porta utenze da 120 a parete

A00120P-I Satellite porta utenze da 120 a parete intermedio

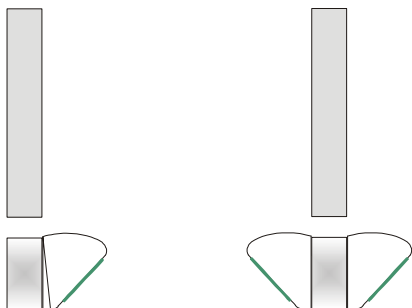

A00120C Satellite porta utenze da 120 centrale

A00120C-I Satellite porta utenze da 120 centrale intermedio



A00150P Satellite porta utenze da 150 a parete

A00150P-I Satellite porta utenze da 150 a parete intermedio

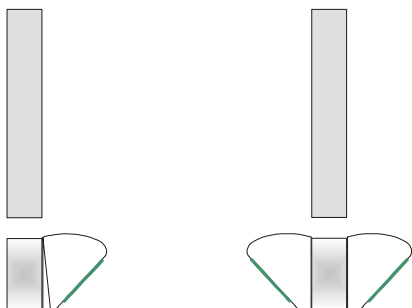

A00150C Satellite porta utenze da 150 centrale

A00150C-I Satellite porta utenze da 150 centrale intermedio

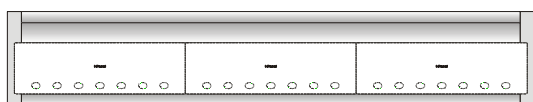

A00180P Satellite porta utenze da 180 a parete

A00180P-I Satellite porta utenze da 180 a parete intermedio

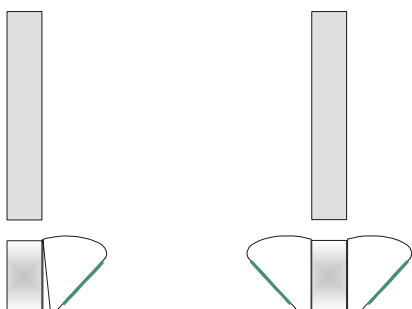

A00180C Satellite porta utenze da 180 centrale

A00180C-I Satellite porta utenze da 180 centrale intermedio

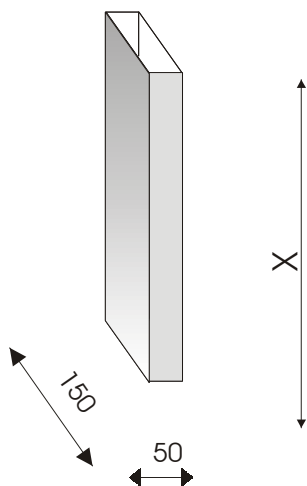
PIANTANA DI SUPPORTO A SOFFITTO

A06000 Piantana di supporto a soffitto sospensione totale
Dimensioni (mm.) L 50 x P 150 x H x = variabile

A06001 Piantana di supporto a soffitto sospensione parziale
Dimensioni (mm.) L 50 x P 150 x H x = variabile

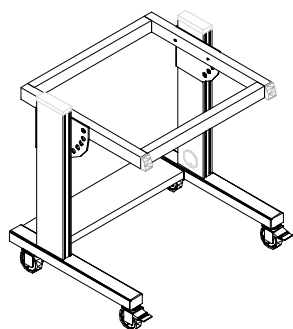
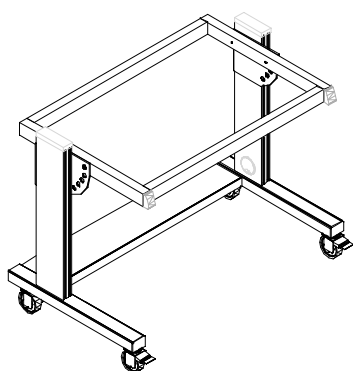
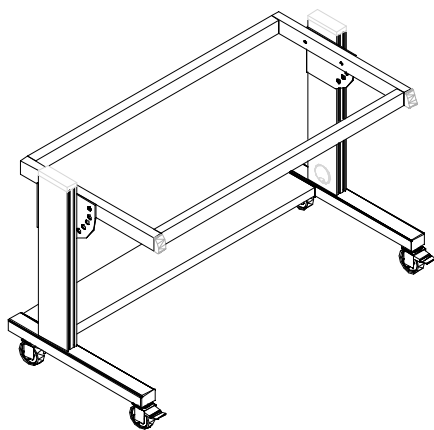
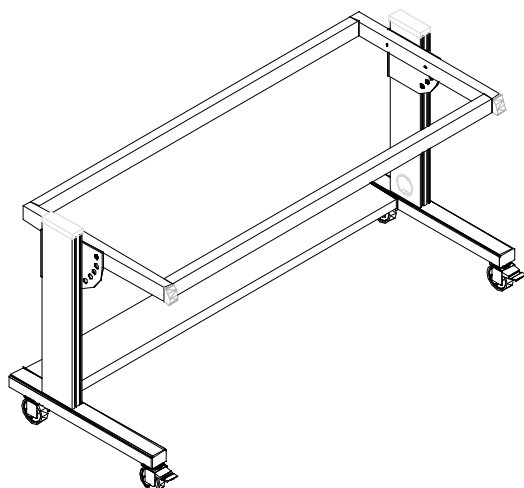
BANCHI CARRELLATI**20091**Struttura per banco mobile da 90x75
Dimensioni (mm.) L 890 x P 710 x H da 400 a 900**20121**Struttura per banco mobile da 120x75
Dimensioni (mm.) L 1190 x P 710 x H da 400 a 900**20151**Struttura per banco mobile da 150x75
Dimensioni (mm.) L 1490 x P 710 x H da 400 a 900**20181**Struttura per banco mobile da 180x75
Dimensioni (mm.) L 1790 x P 710 x H da 400 a 900

SEZIONE LATERALE BANCHI CARRELLATI

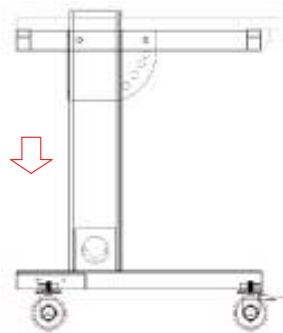

Altezza massima piano di lavoro H 900 mm.

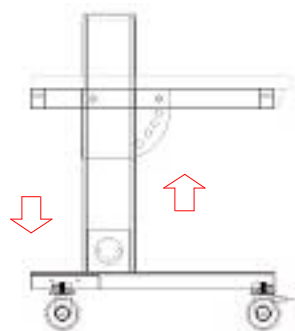

Altezza variabile piano di lavoro da 900 mm a 400 mm

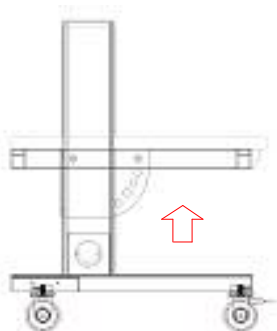

Altezza minima piano di lavoro 400 mm

**PIANI DI LAVORO PER BANCHI CARRELLATI:
IN LAMINATO PLASTICO POSTFORMATO, RESINA FENOLICA,
E GRES MONOLITICO,**



- 30090M** Piano in postformato 90x75
Dimensioni (mm.) L 765 x P 750 x H 40
- 37090** Piano in resina fenolica 90x75
Dimensioni (mm.) L 765 x P 750 x H 20
- 34090B** Piano in gres monolitico 90x75
Dimensioni (mm.) L 765 x P 750 x H 30

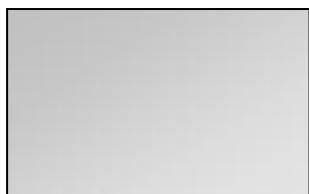

- 30120M** Piano in postformato 120x75
Dimensioni (mm.) L 1065 x P 750 x H 30
- 37120** Piano in resina fenolica 120x75
Dimensioni (mm.) L 1065 x P 750 x H 20
- 34120B** Piano in gres monolitico 120x75
Dimensioni (mm.) L 1065 x P 750 x H 30

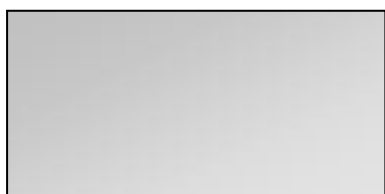

- 30150M** Piano in postformato 150x75
Dimensioni (mm.) L 1365 x P 750 x H 40
- 37150** Piano in resina fenolica 150x75
Dimensioni (mm.) L 1365 x P 750 x H 20
- 34150B** Piano in gres monolitico 150x75
Dimensioni (mm.) L 1365 x P 750 x H 30

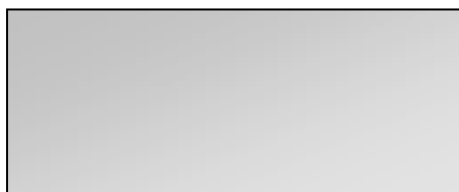

- 30180M** Piano in postformato 180x75
Dimensioni (mm.) L 1665 x P 750 x H 40
- 37180** Piano in resina fenolica 180x75
Dimensioni (mm.) L 1665 x P 750 x H 20
- 34180B** Piano in gres monolitico 180x75
Dimensioni (mm.) L 1665 x P 750 x H 30

MOBILETTI (ALTEZZA 800) SU RUOTE PER BANCHI CARRELLATI



40001 Mobiletto da 45 a 1 anta e 1 ripiano
 Dimensioni (mm.) L 450 x P 500 x H 800

VARIANTI: apertura destra **D**
 apertura sinistra **S**

OPZIONE MULTICOLOR:

| | | |
|---------------------|-----|---|
| anta colore GRIGIO | .01 |  |
| anta colore GIALLO | .02 |  |
| anta colore VERDE | .03 |  |
| anta colore ARANCIO | .04 |  |
| anta VETRATA | .05 |  |

ESEMPIO: **40001S.03** Mobiletto da 45 a 1 anta e 1 ripiano
 colore VERDE apertura a sinistra



40004 Mobiletto da 45 a 2 cassetti e 1 cassettone
 Dimensioni (mm.) L 450 x P 500 x H 800

40005 Mobiletto da 45 a 2 cassetti e 1 porta cartelle
 Dimensioni (mm.) L 450 x P 500 x H 800

Mobiletti dotati di dispositivo anti-ribaltamento



40006 Mobiletto da 45 a 2 cassettoni
 Dimensioni (mm.) L 450 x P 500 x H 800

40007 Mobiletto da 45 a 2 porta cartelle
 Dimensioni (mm.) L 450 x P 500 x H 800

Mobiletti dotati di dispositivo anti-ribaltamento



40008 Mobiletto da 45 a 4 cassetti
 Dimensioni (mm.) L 450 x P 500 x H 800





MOBILETTI (ALTEZZA 800) SU RUOTE PER BANCHI CARRELLATI



40101 Mobiletto da 60 a 1 anta e 1 ripiano
 Dimensioni (mm.) L 600 x P 500 x H 800

VARIANTI: apertura destra **D**
 apertura sinistra **S**

OPZIONE MULTICOLOR:

| | | |
|---------------------|-----|---|
| anta colore GRIGIO | .01 |  |
| anta colore GIALLO | .02 |  |
| anta colore VERDE | .03 |  |
| anta colore ARANCIO | .04 |  |
| anta VETRATA | .05 |  |

ESEMPIO: **40101S.03** Mobiletto da 60 a 1 anta e 1 ripiano
 colore VERDE apertura a sinistra



40103 Mobiletto da 60 a 1 anta, 1 cassetto e 1 ripiano
 Dimensioni (mm.) L 600 x P 500 x H 800



40104 Mobiletto da 60 a 2 cassetti e 1 cassettone
 Dimensioni (mm.) L 600 x P 500 x H 800

40105 Mobiletto da 60 a 2 cassetti e 1 porta cartelle
 Dimensioni (mm.) L 600 x P 500 x H 800

Mobiletti dotati di dispositivo anti-ribaltamento

**MOBILETTI (ALTEZZA 800) SU RUOTE PER BANCHI
CARRELLATI**

40106 Mobiletto da 60 a 2 cassettoni
Dimensioni (mm.) L 600 x P 500 x H 800

40107 Mobiletto da 60 a 2 porta cartelle
Dimensioni (mm.) L 600 x P 500 x H 800

Mobiletti dotati di dispositivo anti-ribaltamento



40108 Mobiletto da 60 a 4 cassetti
Dimensioni (mm.) L 600 x P 500 x H 800



MOBILETTI (ALTEZZA 640) SU RUOTE PER BANCHI CARRELLATI



42001 Mobiletto da 45 a 1 anta e 1 ripiano
 Dimensioni (mm.) L 450 x P 500 x H 640

VARIANTI: apertura destra **D**
 apertura sinistra **S**

OPZIONE MULTICOLOR:

| | | |
|---------------------|------------|---|
| anta colore GRIGIO | .01 |  |
| anta colore GIALLO | .02 |  |
| anta colore VERDE | .03 |  |
| anta colore ARANCIO | .04 |  |
| anta VETRATA | .05 |  |

ESEMPIO: **42001S.03** Mobiletto da 45 a 1 anta e 1 ripiano
 colore VERDE apertura a sinistra



42004 Mobiletto da 45 a 1 cassetto e 1 cassettone
 Dimensioni (mm.) L 450 x P 500 x H 640

42005 Mobiletto da 45 a 1 cassetto e 1 porta cartelle
 Dimensioni (mm.) L 450 x P 500 x H 640

Mobiletti dotati di dispositivo anti-ribaltamento



42008 Mobiletto da 45 a 3 cassetti
 Dimensioni (mm.) L 450 x P 500 x H 640



MOBILETTI (ALTEZZA 640) SU RUOTE PER BANCHI CARRELLATI



42101 Mobiletto da 60 a 1 anta e 1 ripiano
Dimensioni (mm.) L 600 x P 500 x H 640

VARIANTI: apertura destra **D**
apertura sinistra **S**

OPZIONE MULTICOLOR:

| | | |
|---------------------|-----|---|
| anta colore GRIGIO | .01 |  |
| anta colore GIALLO | .02 |  |
| anta colore VERDE | .03 |  |
| anta colore ARANCIO | .04 |  |
| anta VETRATA | .05 |  |

ESEMPIO: **42101S.03** Mobiletto da 60 a 1 anta e 1 ripiano
colore VERDE apertura a sinistra



42104 Mobiletto da 60 a 1 cassetto e 1 cassettone
Dimensioni (mm.) L 600 x P 500 x H 640

42105 Mobiletto da 60 a 1 cassetto e 1 porta cartelle
Dimensioni (mm.) L 600 x P 500 x H 640

Mobiletti dotati di dispositivo anti-ribaltamento



42108 Mobiletto da 60 a 3 cassetti
Dimensioni (mm.) L 600 x P 500 x H 640

I MOBILETTI INDICATI DA CODICE 42001 A CODICE 42108 SONO DISPONIBILI ANCHE NELLA VERSIONE SOSPESI E SCORREVOLI